



# Wind

## What Is Wind?

**Wind** is simply air in motion. It is produced by the uneven heating of the Earth's surface by energy from the sun. Since the Earth's surface is made of very different types of land and water, it absorbs the sun's radiant energy at different rates. Much of this energy is converted into heat as it is absorbed by land areas, bodies of water, and the air over these formations.

On the coast, for example, the land heats up more quickly than the water. The warm air over the land expands and rises, and the heavier, cooler air over the water rushes in to take its place, creating a convection current of moving air, or wind. In the same way, the large atmospheric winds that circle the Earth are produced because the Earth's surface near the Equator receives more of the sun's energy than the surface near the North and South Poles.

### Land Breeze

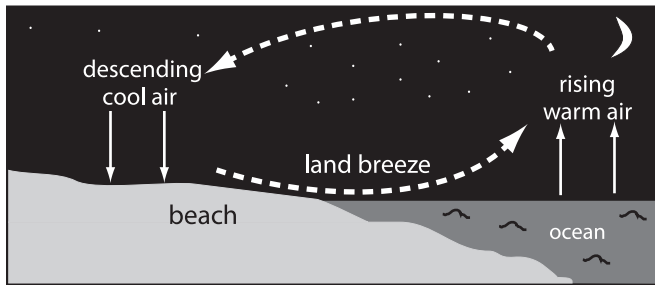

### Sea Breeze

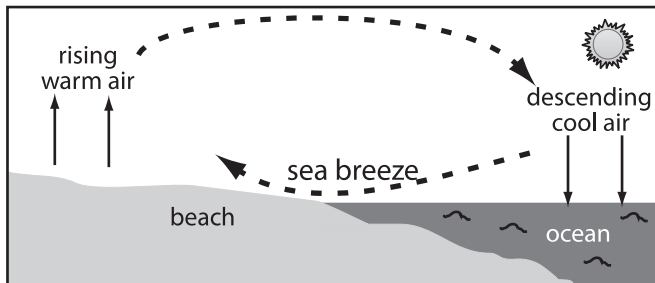

### Windmill



### Weather Vane

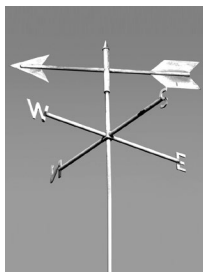

### Anemometer



## Wind at a Glance, 2014

### Classification:

- renewable

### Major Uses:

- electricity

### U.S. Energy Consumption:

- 1.733 Q
- 1.73%

### U.S. Energy Production:

- 1.733 Q
- 1.98%

Data: Energy Information Administration

Wind is called a **renewable** energy source because wind will continually be produced as long as the sun shines on the Earth. Today, wind energy is mainly used to generate electricity.

## The History of Wind

Throughout history, people have harnessed the wind in many ways. Over 5,000 years ago, the ancient Egyptians used wind power to sail their ships on the Nile River. Later, people built windmills to grind their grain. The earliest known windmills were in Persia (Iran). These early windmills looked like large paddle wheels.

Centuries later, the people of Holland improved the basic design of the windmill. They gave it propeller-type blades made of fabric sails and invented ways for it to change direction so that it could continually face the wind. Windmills helped Holland become one of the world's most industrialized countries by the 17th century.

American colonists used windmills to grind wheat and corn, pump water, and cut wood. As early as the 1920s, Americans used small windmills to generate electricity in rural areas without electric service. When power lines began to transport electricity to rural areas in the 1930s, local windmills were used less and less, though they can still be seen on some Western ranches.

The oil shortages of the 1970s changed the energy picture for the country and the world. It created an environment more open to alternative energy sources, paving the way for the re-entry of the windmill into the American landscape to generate electricity.

## Monitoring Wind Direction

A weather vane, or wind vane, is a device used to monitor the direction of the wind. It is usually a rotating, arrow-shaped instrument mounted on a shaft high in the air. It is designed to point in the direction of the source of the wind.

Wind direction is reported as the direction from which the wind blows, not the direction toward which the wind moves. A north wind blows from the north, toward the south.

# Wind

## Wind Velocity

It is important to know how fast the wind is blowing. Wind speed is important because the amount of electricity that wind turbines can generate is determined in large part by wind speed, or velocity. A doubling of wind velocity from the low range to optimal range of a turbine can result in eight times the amount of power produced. This is a huge difference and helps wind companies decide where to site wind turbines.

Wind speed can be measured with wind gauges and **anemometers**. One type of anemometer is a device with three arms that spin on top of a shaft. Each arm has a cup on its end. The cups catch the wind and spin the shaft. The harder the wind blows, the faster the shaft spins. A device inside counts the number of rotations per minute and converts that figure into miles per hour (mph). A display on the anemometer shows the speed of the wind.

## Modern Wind Machines

Today, wind is harnessed and converted into electricity using turbines called **wind turbines**. The amount of electricity that a turbine produces depends on its size and the speed of the wind. Most wind turbines have the same basic parts: blades, a tower, and a gear box. These parts work together to convert the wind's kinetic energy into motion energy that generates electricity through the following steps:

1. The moving air spins the turbine blades.
2. The blades are attached to the turbine by a hub. The hub is connected to a low-speed shaft. When the blades spin, the shaft turns.
3. The low-speed shaft is connected to a gear box. Inside, a large slow-moving gear turns a small gear quickly.
4. The small gear turns another shaft at high speed.
5. The high-speed shaft is connected to a generator. As the shaft turns the generator, it produces electricity.
6. The electric current is sent through cables down the turbine tower to a transformer that changes the voltage of the current before it is sent out on transmission lines.

Wind turbines are most efficient when they are built where winds blow consistently, at least 8 miles per hour. Faster winds generate more electricity, but if the wind speed is too fast, generation declines. High above ground winds are stronger and steadier. Wind turbines today are typically placed on top of towers that are about 80 meters (260 feet) tall.

There are many different types of wind turbines with different blade shapes. Different types of turbines operate most efficiently at different wind speeds. While one turbine might operate efficiently in winds as low as five miles per hour, another may need winds up to 45 miles per hour.

Wind turbines also come in different sizes, based on the amount of electric power they can generate. Small turbines may produce only enough electricity to power a few appliances in one home. Large turbines are often referred to as 'utility-scale' because they generate enough power for utilities, or electric companies, to sell. The largest turbines in the U.S. produce 1.5 to 7.5 megawatts (MW), enough electricity to power 375 to 1,875 homes. Large turbines are grouped together into **wind farms**, which provide bulk power to the electrical grid.

## Sample Power Curve of a Wind Turbine

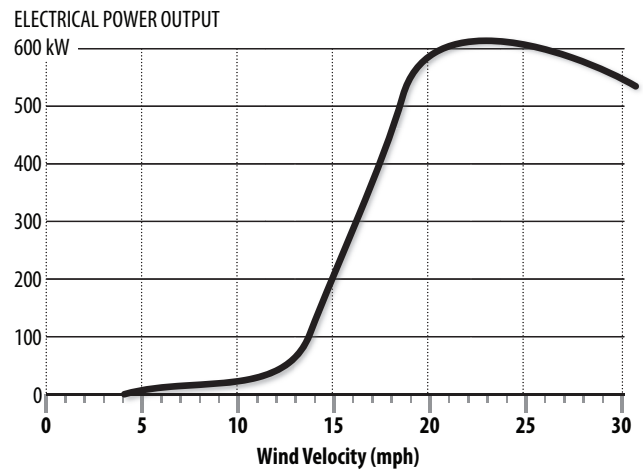

## Wind Turbine Diagram

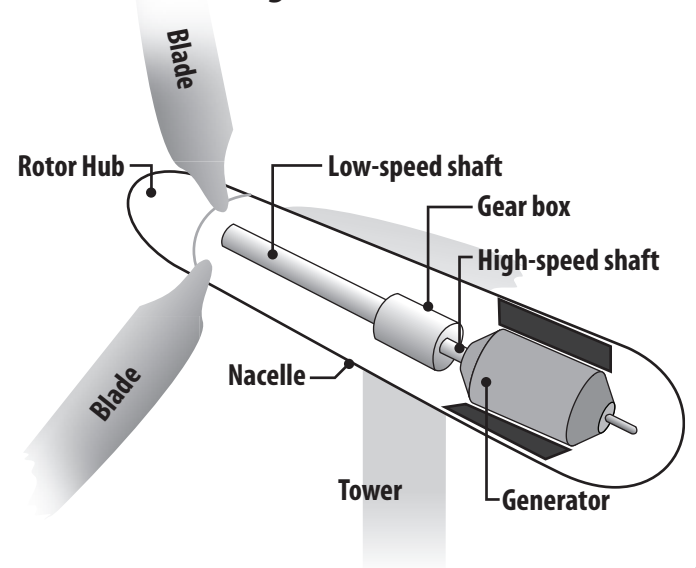

## Wind Power Plants

Wind power plants, or wind farms, are clusters of wind turbines grouped together to produce large amounts of electricity. Choosing the location of a wind farm is known as siting a wind farm. To build a wind farm, wind speed and direction must be studied to determine where to put the turbines. As a rule, wind speed increases with height and over open areas with no windbreaks. The site must have strong, steady winds. Scientists measure the wind in an area for several years before choosing a site.

The best sites for wind farms are on hilltops, the open plains, through mountain passes, and near the coasts of oceans or large lakes. Turbines are usually built in rows facing into the prevailing wind. Placing turbines too far from each other wastes space. If turbines are too close together they block each other's wind.

There are many factors to consider when siting a wind farm, such as:

**What is the weather like? Do tornadoes, hurricanes, or ice storms affect the area?** Any of these may cause expensive damage to the wind turbines.

**Is the area accessible for workers? Will new roads need to be built?** New roads are expensive to build.

**Can the site be connected to the power grid?** It is expensive to lay long-distance transmission lines to get electricity to where people live, so wind farms should be located near the areas where electricity is needed.

**Will the wind farm impact wildlife in the area?** Developers building a wind farm need to get permission from the local community and government before building. There are strict building regulations to follow.

Wind plants need a lot of land. Each turbine requires about 0.25 acres of land. A wind power plant can cover hundreds of acres of land, plus each tower should be five to ten turbine diameters away from each other, depending on the number of turbines. On the plus side, most of the land is still available for other uses. Ranchers, for example, can grow grain or graze cattle around the turbines once they have been installed.

Some wind farms are being constructed **offshore** in shallow water where there is consistent wind speed much of the time. The wind

blows stronger and steadier over water than land. There are no obstacles on the water to block the wind. There is a lot of wind energy available offshore. Offshore wind farms are built in the shallow waters off the coast of major lakes and oceans. While offshore turbines produce more electricity than turbines on land, they cost more to build and operate. Offshore construction is difficult and expensive. The cables that carry the electricity must be buried deep under the water.

An offshore wind farm in the U.S., Cape Wind Energy Project, received final approval from the Bureau of Ocean Energy Management, Regulation and Enforcement in April 2011. Having cleared several legal and logistical hurdles, the project is currently stalled in its financing and commercial contracting stage. Construction has yet to begin on this project.

The U.S. will see its first offshore wind farm come online in 2016, however. The Deepwater Wind Project, southeast of Block Island, Rhode Island, is under construction and will finalize construction in 2016. This five-turbine, 30-megawatt farm will power 17,000 homes.

After a plant has been built, there are ongoing maintenance costs. In some states, these costs are offset by tax breaks given to power plants that use renewable energy sources.

Unlike coal or nuclear plants, many wind plants are not owned by public utilities. Instead they are owned and operated by business people who sell the electricity produced to electric utilities. These private companies are known as independent power producers (IPPs). The Public Utility Regulatory Policies Act, or PURPA, requires utility companies to purchase electricity from independent power producers at rates that are fair.





## OFFSHORE WIND FARM



## Wind Resources

Where is the best place to build a wind plant? There are many good sites for wind farms in the United States including California, Alaska, Hawaii, the Great Plains, and mountainous regions. An average wind speed of 8-13 miles per hour (mph) is needed to convert wind energy into electricity economically. Currently, wind generates electricity in 37 states. Texas leads the nation, producing over one-fifth of the wind-generated electricity in the country.

### Average Wind Speed at 80 Meters Altitude

-  Faster than 9.5 m/s (faster than 21.3 mph)
-  7.6 to 9.4 m/s (17 to 21.2 mph)
-  5.6 to 7.5 m/s (12.5 to 16.9 mph)
-  0 to 5.5 m/s (0 to 12.4 mph)

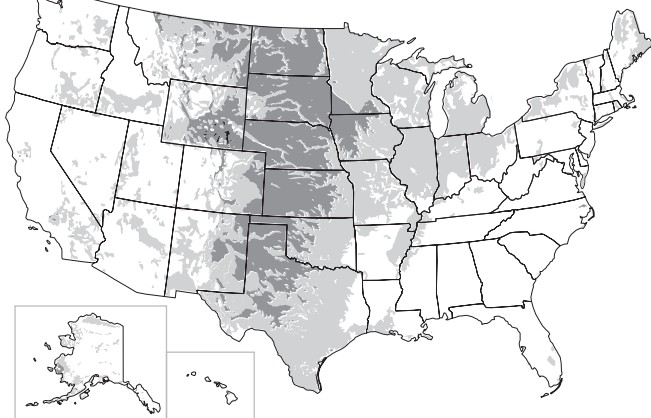

Data: National Renewable Energy Laboratory

### Top Wind States (Net Electricity Generation), 2014

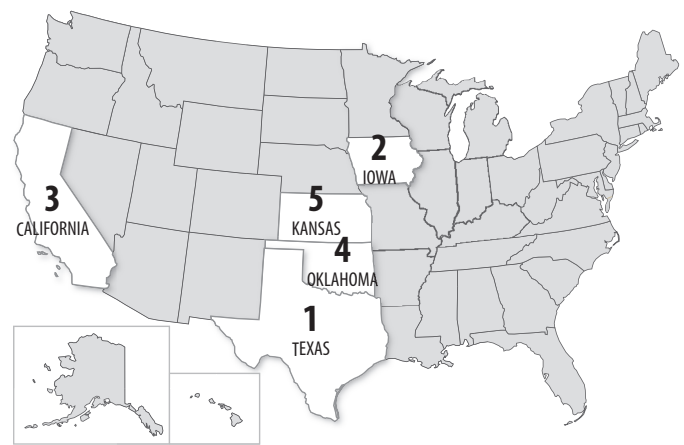

Data: Energy Information Administration



## Wind Production

How much energy can we get from the wind? There are two terms to describe basic electricity production: efficiency and capacity factor. **Efficiency** refers to how much useful energy (electricity, in this case) we can get from an energy source. A 100 percent energy efficient machine would change all the energy put into it into useful energy. It would not waste any energy.

There is no such thing as a 100 percent energy efficient machine. Some energy is always lost or wasted when one form of energy is converted to another. The lost energy is usually in the form of heat, which dissipates into the air and cannot be used again economically.

How efficient are wind turbines? Wind turbines are just as efficient as most other plants, such as coal plants. Wind turbines convert 25 to 45 percent of the wind's kinetic energy into electricity. A coal-fired power plant converts about 35 percent of the chemical energy in coal into usable electricity.

**Capacity** refers to the capability of a power plant to produce electricity. A power plant with a 100 percent capacity rating would run all day, every day at full power. There would be no down time for repairs or refueling, an impossible goal for any plant. Coal plants typically have a 65 to 75 percent capacity factor since they can run day or night, during any season of the year.

Wind power plants are different from power plants that burn fuel. Wind plants depend on the availability of wind, as well as the speed of the wind. Therefore, wind turbines cannot operate 24 hours a day, 365 days a year.

A wind turbine at a typical wind farm operates 65 to 90 percent of the time, but usually at less than full capacity because the wind speed is not at optimum levels. Therefore, its capacity factor is 30 to 35 percent.

Economics also plays a large part in the capacity of wind turbines. Turbines can be built that have much higher capacity factors, but it is not economical to do so. The decision is based on electricity output per dollar of investment.

One 2.5 megawatt turbine can produce about 7.7 million kilowatt-hours (kWh) of electricity a year. That is enough electricity for more than 700 homes per year. In this country, wind turbines produce 181.7 billion kWh of energy a year. Wind energy provides 4.44 percent of the nation's electricity, which is enough electricity to serve at least 16 million households.

Wind is the fastest growing energy technology in the world today. In the last four years, wind capacity worldwide has nearly doubled. In 2015 China was the largest installer of new wind capacity. The United States, Germany, India, and Spain join China as the countries with the most installed wind capacity.

Investment in wind energy is increasing because its cost has come down and the technology has improved. Wind is now one of the most competitive sources for new generation. Another hopeful sign for the wind industry is consumer demand for **green pricing**. Many utilities around the country now allow customers to voluntarily choose to pay more for electricity generated by renewable sources.

## Small Wind Systems

Wind turbines are not only on wind farms or offshore, they can also be found on the property of private residences, small businesses, and schools. A typical home uses approximately 900 kilowatt-hours of electricity each month. Many people are choosing to install small wind turbines to lower or eliminate their electricity bills.

Siting a small wind turbine is similar to siting large turbines. Potential small wind users need to make sure that there is plenty of unobstructed wind. The tip of the turbine blade needs to be at least nine meters (30 feet) higher than the tallest wind obstacle. Sometimes this can be a challenge for installing a residential wind turbine if local zoning laws have height limitations. The turbine also requires open land between the turbine and the highest obstacle. Depending on the size of the turbine, this may require a 70 to 150 meter (250 to 500 foot) radius. Specific siting recommendations can be obtained from the turbine manufacturer.

## Wind Economics

On the economic front, there is a lot of good news for wind energy. First, a wind plant is less expensive to construct than a conventional coal or nuclear plant. Wind plants can simply add wind turbines as electricity demand increases.

Second, the cost of producing electricity from the wind has dropped dramatically. Electricity generated by the wind cost 80 cents per kWh in 1980, but now costs about five cents per kWh or less. New turbines are lowering the cost even more.

Installing a wind turbine on a residential property can be expensive. The Emergency Economic Stabilization Act of 2008 created energy tax incentives to encourage large and small companies, along with individuals, to make energy improvements and invest in renewable energy. Included in this bill is an extension and modification to the Residential Energy Efficient Property Credit. Through December 31, 2016, individuals can receive a 30 percent tax credit for installing a small wind system, up to 100 kilowatts. Some states and utilities offer additional incentives to residents to install renewable energy systems.

## Wind Energy and the Environment

Wind energy offers a viable, economical alternative to conventional power plants in many areas of the country. Wind is a clean fuel; wind farms produce no air or water pollution because no fuel is burned.

The most serious environmental drawbacks to wind turbines may be their negative effect on wild bat populations and the visual impact on the landscape. To some, the glistening blades of windmills on the horizon are an eyesore; to others, they're a beautiful alternative to conventional power plants.